

MAHLE

Driven by performance

ENGINE BEARING:

FAILURE ANALYSIS AND CORRECTION

Technical information

AFTERMARKET

CLEVITE

Table of contents

1	Preface	3
2	Recommended bearing installation tolerances	4
3	Crankshaft and engine bearing installation	6
4	Normal appearance	7
5	Foreign particles in lining	8
6	Foreign particles on bearing back	9
7	Misassembly	10
8	Shifted bearing cap	11
9	Excessive crush	12
10	Insufficient crush	13
11	Bent or twisted connecting rod	14
12	Fillet ride	15
13	Distorted crankcase	16
14	Bent crankshaft	17
15	Out-of-round bore	18
16	Out-of-shape journal	19
17	Oil starvation	20
18	Hot short	21
19	Surface fatigue	22
20	Corrosion	23
21	Accelerated wear	24
22	Crankshaft grinding and polishing	25
23	Premature thrust bearing failure	27
24	Preventing premature cam bearing failure	31
25	Crankshaft thrust faces	33

1 Preface

As you know, every automotive engine part will eventually wear out. If every part always performed for the full length of its expected life, your job would be fairly simple – to replace parts that have worn. Unfortunately, we cannot always count on an engine part failing only because its normal lifespan is exceeded. Mechanics must not only be a “replacer of parts” but they must be capable of diagnosis to determine why a part failed prematurely. The table below lists the eight major causes of premature engine bearing failure, along with percentage figures which indicate how often each has been found to be the prime contributor to a bearing’s destruction. However, it is important to note that in many cases a premature bearing failure is due to a combination of several of these causes.

MAJOR CAUSES OF PREMATURE BEARING FAILURE

Dirt	45.4%
Misassembly	12.8%
Misalignment	12.6%
Insufficient Lubrication	11.4%
Overloading	8.1%
Corrosion	.3.7%
Improper Journal Finish	3.2%
Other	.2.8%

Thus we can reason that if a mechanic merely replaces a damaged bearing in an engine, without determining the cause of its failure, more than 99% of the time they will be subjecting the replacement bearing to the same cause that was responsible for the original failure. What this all means is that just as doctors cannot cure a patient until they have determined what ails him, so, too, mechanics cannot correct the cause of premature bearing failure until they first determine what causes the failure.

The pages of this manual are organized, for your convenience, into four major subjects:

1. **Appearance** – an illustration and brief description of a bearing that has failed due to a specific cause.
2. **Damaging Action** – what actually damaged the bearing under the conditions which were present.
3. **Possible Causes** – a listing of those factors capable of creating the particular damaging action.
4. **Corrective Action** – the action that should be taken to correct the cause of failure.

We believe you will find this reference manual easy to read and use, and that it will be very helpful to you in properly determining the cause of premature bearing failure.

2 Recommended bearing installation tolerances

CRANKCASE TOLERANCES

Finish of Main Bores:

- 60-90 micro inches Ra.

Bore Tolerance:

- .001" (.025mm) up to 10.000" (250mm) bore

Out-of-Round:

- .001" (.025mm) maximum if horizontal is larger than vertical

Alignment:

- .002" (.050mm) maximum overall misalignment (.001"-.025mm for heavy duty or highly loaded engines)
- .001" (.025mm) maximum misalignment on adjacent bores (.0005"-.013mm for heavy duty or highly loaded engines)

CRANKSHAFT TOLERANCES

MAIN BEARING AND CRANKPIN JOURNALS

Finish of Journals:

- 15 micro inches Ra or better (10 micro inches Ra or better for heavy duty or highly loaded engines)

Diameter Tolerance:

- .0005" (.013mm) up to 1.500" (38mm) journal
- .001" (.025mm) for 1.500" (38mm) to 10.000" (250mm) journal

Out-of-Round:

- .0005"(.013mm) maximum up to 5.000" (125mm) journal (.0002"-.005mm for heavy duty or highly loaded engines)
- Never use a maximum out-of-round journal with a maximum out-of-round bore.

Taper:

- .0002" (.005mm) maximum up to 1.000" (25mm) long journal (.0001"-.003mm for heavy duty or highly loaded engines)
- .0004" (.010mm) maximum for 1.000" (25mm) to 2.000" (50mm) long journal (.0002"-.005mm for heavy duty or highly loaded engines)
- .0005" (.013mm) maximum for 2.000" (50mm) or longer journal (.0003"-.008mm for heavy duty or highly loaded engines)

Alignment:

- .001" (.025mm) maximum misalignment on adjacent journals (.0005"-.013mm for heavy duty or highly loaded engines)
- .002" (.050mm) maximum overall misalignment (.001"-.025mm for heavy duty or highly loaded engines)
- Crankpin and main journals should be parallel within .001" (.025mm) (.0005"-.013mm for heavy duty or highly loaded engines)

Hour-Glass or Barrel Shape Condition: Same as taper

Oil Holes must be well blended into journal surface.

2 Recommended bearing installation tolerances contd.

CRANKCASE END CLEARANCE

Shaft Diameter	End Clearance
2.000"-2.750" (50mm-70mm)	.003"-.007" (.075mm-.175mm)
2.813"-3.500" (71mm-88mm)	.005"-.009" (.125mm-.225mm)
3.500" or over (89mm or over)	.007"-.011" (.175mm-.275mm)

CONNECTING ROD END CLEARANCE

Fillets at end of crankpin should not bind on ends of rod bearing, .004" (.10mm) to .010" (.25mm) clearance recommended.

BEARING SPREAD

Main bearings: .005" (.13mm) to .020" (.50mm) in excess of crankcase bore diameter

Connecting rod bearings: .020" (.50mm) in excess of rod bore

Finish of Rod Bores:

- 60-90 micro inches

Rod Tolerance:

- .0005" (.013mm) up to 3.250" (81mm) diameter
- .001" (.025mm) from 3.250" (81mm) to 10.000" (250mm) diameter

Out-of-Round:

- .001" (.025mm) maximum if horizontal is larger than vertical

Taper:

- .0002" (.005mm) up to 1.000" (25mm) length (.0001"-.0003mm for heavy duty or highly loaded engines)
- .0004" (.010mm) for 1.000" (25mm) to 2.000" (50mm) length (.0002"-.0005mm for heavy duty or highly loaded engines).
- .0005" (.013mm) for 2.000" (50mm) or longer (.0003"-.0008mm for heavy duty or highly loaded engines)

Hour-Glass or Barrel Shape Condition: Same as taper

Parallelism between rod bore and wrist pin hole .001" (.025mm) in 5.000" (125mm)

Twist .001" (.025mm) in 6.000" (150mm)

OIL CLEARANCE - RESIZED BEARINGS

The oil clearance shown in this catalog are for the factory manufactured precision sizes. When installing a resized bearing, adjust the oil clearance shown as follows:

For babbitt and TM-77 copper-lead: Add .0004" (.010mm) to both low and high limit

For TM-112 copper-lead: Add .0008" (.020mm) to low limit and .0004" (.010 mm) to high limit

PIN BUSHINGS

Resizing:

- Light Ream: .007"/.015"
- Bore: .015"/.030"

3 Crankshaft and engine bearing installation guidelines

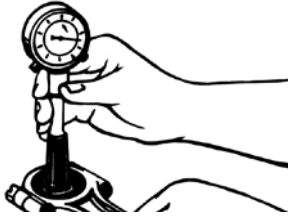

1. Check all connecting rod housing bores for taper, roundness and size, using a bore gauge or inside micrometer. Check for parallelism between the large and small ends of rod. Check condition of bolts and threads.

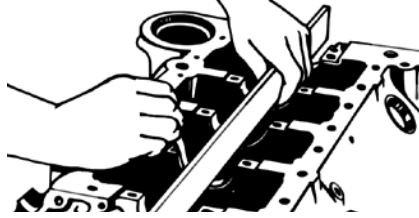

2. Check main bearing bores for alignment, taper, roundness and size. Check condition of bolts and threads.



3. Make sure that engine block and crankshaft are clean, checking oil passageways for hidden dirt and debris. Hot water and detergent work best for cleaning.



4. While installing both connecting rod bearings and main bearings, check for proper oil clearance, using Clevite® Plastigage®*.



5. With engine block upside down, install the upper main halves, making sure bearing backs and bores are clean and dry.



6. Check oil hole alignment to insure proper oil flow.



7. Lubricate all bearings and seal lip surfaces using Clevite® Bearing Guard**. Bearing Guard can be used on any internal engine component as an assembly lube.

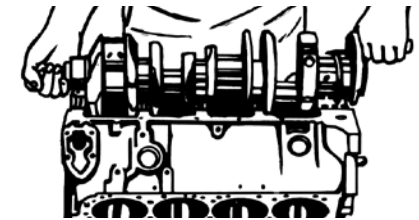

8. Place the crankshaft squarely into the main bearings and assemble lower main bearings and caps. Check to insure proper position.

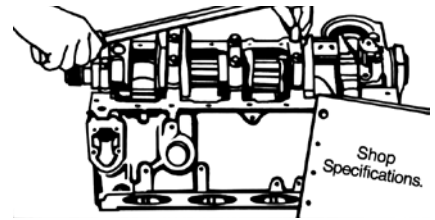

9. Pry crankshaft squarely into the main bearings and assemble lower main bearings and caps. Check to insure proper position.



10. Assemble the connecting rod and piston assembly to the crankshaft, using Clevite® Bolt Boots‡ to protect crankshaft journals and cylinder walls. Make sure caps match correct rods, and torque bolts to proper OE specifications.



11. With crankshaft forced all the way forward in block, check end clearance between the crankshaft thrust face and the bearing flange to OE specification, using a feeler gauge of proper thickness.



12. Prime engine oiling system before starting engine to assure operation of oil pump and lubrication system immediately upon start-up.

* Part #MPG-1,.001"-.003"; #MPR-1,.002"-.006"; #MPB-1,.004"-.009"; #MPY-1,.009"-.020"
 ** Part #2800B2 - 8 oz. bottle; #2800B4 - 1 gal. jug; #2800B5 - 1 1/3 oz. pkg. • ‡ Part #2800B1

4 Normal appearance

Uniform wear pattern over approximately 2/3 of the bearing's surface. Wear should diminish near the parting line ends of the bearing, and the wear pattern should extend uniformly across the bearing in the axial direction.



For technical service call:
1-800-248-9606

**HOURS: 8:30 AM - 6:00 PM EST
(MONDAY - FRIDAY)**

Use Of Clevite® engine bearings & engine parts, MAHLE Original® pistons and rings and Victor Reinz® gaskets products in aircraft or other specialty equipment may be a violation of Local, State or Federal Regulatory Agency laws, rules and regulations.

These products are intended solely for automotive applications. Under absolutely NO circumstances should these products ever be used in non-automotive applications including, without limitation, aircraft engines, medical equipment, atomic energy devices or reactors.

“Federal, State and local laws restrict the removal, rendering inoperative, or in some cases the modification of factory installed emission devices or systems. California restricts the use of parts which could increase emissions in vehicles designed

for use on public streets or highways. The sale or installation on emission controlled vehicles of certain emission control components not approved by the California Air Resources Board, which alter or modify the original design or performance of such vehicle's emission control system is prohibited. Some of the parts listed and offered for sale in this catalog may fall within the above restrictions. Such parts are intended only for use on off-road vehicles competing in competitive events or on other types of vehicles which are exempt from the applicable emission control laws. Installation of these parts on vehicles subject to emission control laws may be prohibited.

MAHLE Aftermarket recommends that the applicable emission control laws be reviewed before considering the installation of add-on or modified parts.”

Teflon and Viton are registered trademarks of DuPont Corporation.

5 Foreign particles in lining

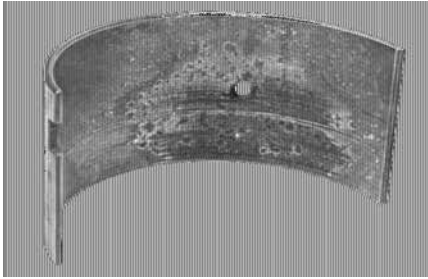

APPEARANCE

Foreign particles are embedded in the lining of the bearing. Scratch marks may also be visible on the bearing surface.

DAMAGING ACTION

Dust, dirt, abrasives and/or metallic particles present in the oil supply embed in the soft babbitt bearing lining, displacing metal and creating a high-spot.

The high-spot may be large enough to make contact with the journal causing a rubbing action that can lead to the eventual breakdown and rupture of the bearing lining. Foreign particles may embed only partially and the protruding portion may come in contact with the journal and cause a grinding wheel action.

POSSIBLE CAUSES

1. Improper cleaning of the engine and parts prior to assembly.
2. Road dirt and sand entering the engine through the air-intake manifold or faulty air filtration.
3. Wear of other engine parts, resulting in small fragments of these parts entering the engine's oil supply.
4. Neglected oil filter and/or air filter replacement.

CORRECTIVE ACTION

1. Install new bearings, being careful to follow proper cleaning procedures.
2. Grind journal surfaces if necessary.
3. Recommend that the operator have the oil, air filter, oil filter and crankcase breather-filter replaced as recommended by the manufacturer.

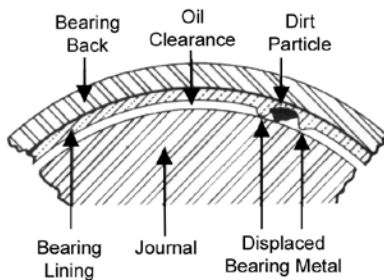

6 Foreign particles on bearing back

APPEARANCE

A localized area of wear can be seen on the bearing surface. Also, evidence of foreign particle(s) may be visible on the bearing back or bearing housing directly behind the area of surface wear.

DAMAGING ACTION

Foreign particles between the bearing and its housing prevent the entire area of the bearing back from being in contact with the housing base. As a result, the transfer of heat away from the bearing surface is not uniform causing localized heating of the bearing surface which reduces the life of the bearing.

Also, an uneven distribution of the load causes an abnormally high pressure area on the bearing surface, increasing localized wear on this material.

POSSIBLE CAUSES

Dirt, dust abrasives and/or metallic particles either present in the engine at the time of assembly or created by a burr removal operation can become lodged between the bearing back and bearing housing during engine operation.

CORRECTIVE ACTION

1. Install new bearings following proper cleaning and burr removal procedures for all surfaces.
2. Check journal surfaces and if excessive wear is discovered, regrind.

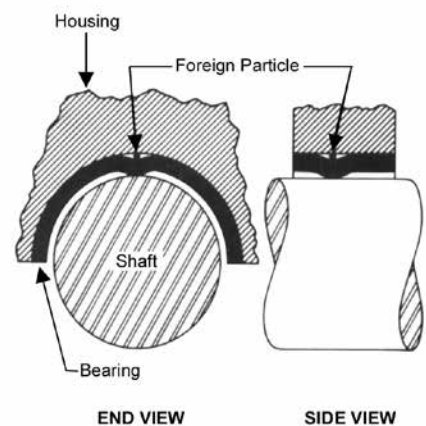

7 Misassembly

Engine bearings will not function properly if they are installed wrong. In many cases, misassembly will result in premature failure of the bearing.

The following are typical assembly errors most often made in the installation of engine bearings.

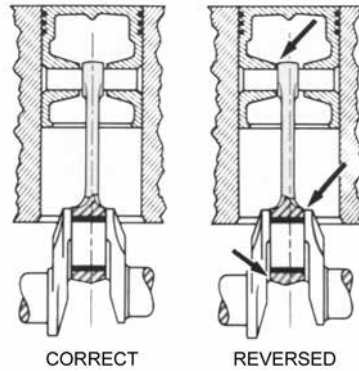

Position of offset connecting rod reversed

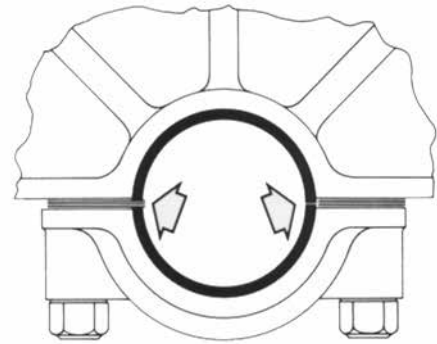

Shims improperly installed

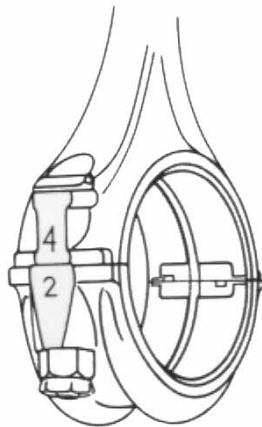

Bearing caps in wrong or reversed position

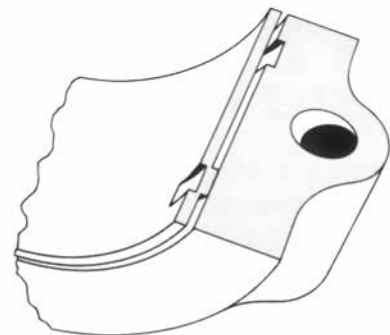

Locating lug not nested

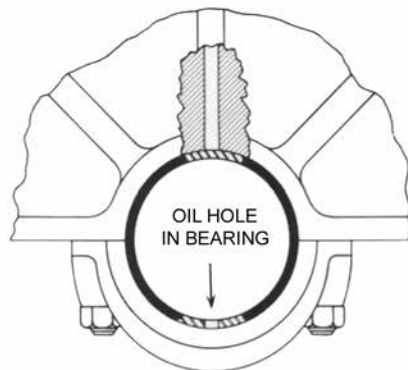

Bearing halves reversed

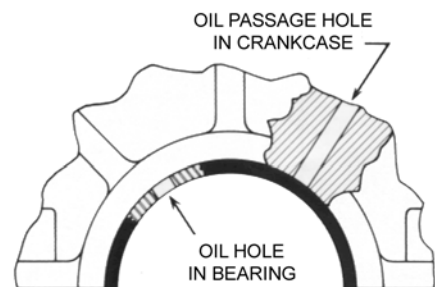

Bearing oil hole not aligned with oil passage hole

8 Shifted bearing cap

APPEARANCE

Excessive wear areas can be seen near the parting lines on opposite sides of the upper and lower bearing shells.

DAMAGING ACTION

The bearing cap has been shifted, causing one side of each bearing-half to be pushed against the journal at the parting line.

The resulting metal-to-metal contact and excessive pressure cause deterioration of the bearing surface and above normal wear areas.

POSSIBLE CAUSES

1. Using too large a socket to tighten the bearing cap. In this case, the socket crowds against the cap causing it to shift.
2. Reversing the position of the bearing cap.
3. Inadequate dowel pins between bearing cap and housing (if used), allowing the cap to break away and shift.
4. Improper torquing of cap bolts resulting in a "loose" cap that can shift positions during engine operation.
5. Enlarged cap bolt holes or stretched cap bolts, permitting greater than normal play in the bolt holes.

CORRECTIVE ACTION

1. Check journal surfaces for excessive wear and regrind if necessary.
2. Install the new bearing being careful to use the correct size socket to tighten the cap and the correct size dowel pins (if required).
3. Alternate torquing from side to side as to assure proper seating of the cap.
4. Check the bearing cap and make sure it's in its proper position.
5. Use new bolts to assure against overplay within the bolt holes.

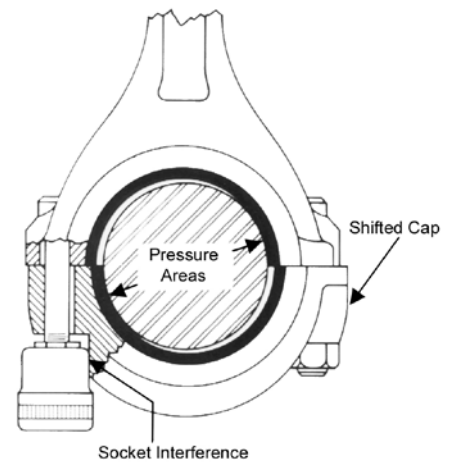

9 Excessive crush

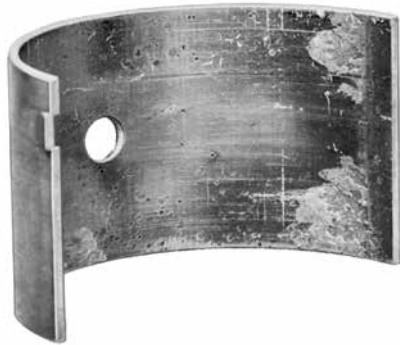

APPEARANCE

Extreme wear areas visible along the bearing surface adjacent to one or both of the parting line.

DAMAGING ACTION

Before the bearing cap is assembled, a small portion of the bearing extends just a little beyond the edge of the bearing housing. Thus when the bearing cap is tightened into place, the bearing is forced against the bearing housing. That portion of the bearing which extends beyond the housing is called “crush”.

When there is too much crush, however, the additional compressive force created by the surplus crush that still remains after the bearing is fully seated causes the bearing to bulge inward at the parting faces. This bearing distortion is called “side pinch.”

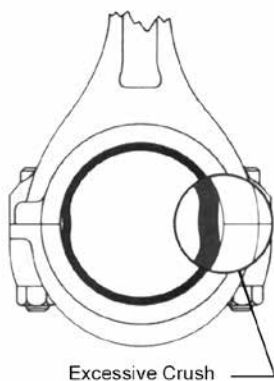

POSSIBLE CAUSES

1. The bearing caps were filed down in an attempt to reduce oil clearance.
2. The bearing caps were assembled too tightly due to excessive torquing.
3. Not enough shims were utilized (if shims were specified).

CORRECTIVE ACTION

1. Rework the bearing housing of the engine block if it has been filed down.
2. Replace the connecting rod if its bearing cap has been filed down.
3. Check journal surfaces and regrind if necessary.
4. Install the new bearing and follow proper installation procedures by never filing down bearing caps and using the recommended torque wrench setting.
5. Correct the shim thickness (if applicable).
6. Check for out-of-roundness of the inside diameter of the assembled bearing by means of an out-of-roundness gauge, inside micrometer, calipers or prussian blue to assure that any out-of-roundness is within safe limits. The maximum assembled bearing I.D. should always be across the split line.

10 Insufficient crush

APPEARANCE

Highly polished areas are visible on the bearing back and/or on the edge of the parting line. Areas of pock marks or build-up due to metal transfer between bearing and housing. This is commonly referred to as “fretting”.

DAMAGING ACTION

When a bearing with insufficient crush is assembled in an engine, it is loose and therefore free to work back and forth within its housing.

Because of the loss of radial pressure, there is inadequate contact with the bearing housing, thus impeding heat transfer away from the bearing. As a result, the bearing overheats causing deterioration of the bearing surface.

POSSIBLE CAUSES

1. Bearing parting faces were filed down in a mistaken attempt to achieve a better fit, thus removing the crush.
2. Bearing caps were held open by dirt or burrs on the contact surface.
3. Insufficient torquing during installation (be certain bolt doesn't bottom in a blind hole).
4. The housing bore was oversize or the bearing cap was stretched, thus minimizing the crush.
5. Too many shims were utilized (if shims are specified).

CORRECTIVE ACTION

1. Clean mating surfaces of bearing caps and inspect for nicks and burrs prior to assembly.
2. Check journal surfaces for excessive wear and regrind if necessary.
3. Check the size and condition of the housing bore and recondition if necessary.
4. Correct shim thickness (if applicable).
5. Install new bearings using correct installation procedures (never file bearing parting faces).

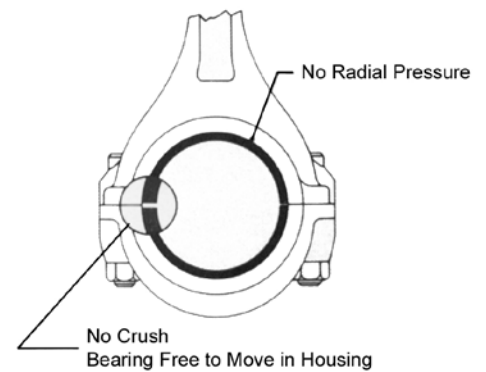
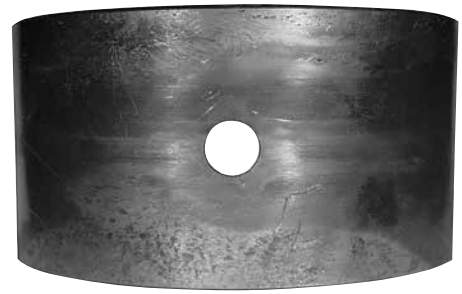

11 Bent or twisted connecting rod

APPEARANCE

Excessive wear areas can be seen on opposite ends of the upper and lower connecting rod bearing shells. The wear is localized on one portion of the bearing surface with little or no wear on the remainder.

DAMAGING ACTION

A bent or twisted connecting rod results in misalignment of the bore, causing the bearing to be cocked so the bearing edge makes metal-to-metal contact with the journal. These metal-to-metal contact areas cause excessive wear on the bearing surface.

POSSIBLE CAUSES

Three factors can contribute to connecting rod distortion:

1. Extreme operating conditions such as "hot rodding" and "lugging."
2. Improper reconditioning.
3. Dropping or abusing the connecting rod prior to assembly.

CORRECTIVE ACTION

1. Inspect connecting rod and recondition or replace if bent or twisted.
2. Check journal surfaces for excessive wear and regrind if necessary.
3. Install bearing.
4. Avoid dropping or abusing the connecting rod prior to assembly.
5. Use proper installation techniques.
6. Check related upper cylinder parts and replace if necessary.

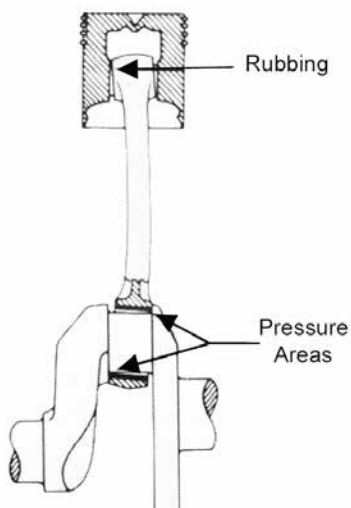

12 Fillet ride

APPEARANCE

When fillet ride has caused a bearing to fail, areas of excessive wear are visible on the extreme edges of the bearing surface.

DAMAGING ACTION

If the radius of the fillet at the corner where the journal blends into the crank is larger than required, it is possible for the edge of the engine bearing to make metal-to-metal contact and ride on this oversize fillet.

This metal-to-metal contact between the bearing and fillet causes excessive wear, leading to premature bearing fatigue.

POSSIBLE CAUSES

Fillet ride results if excessive fillets are left at the edges of the journal at the time of crankshaft machining.

CORRECTIVE ACTION

1. Regrind the crankshaft paying particular attention to allowable fillet radii.
NOTE: Be careful not to reduce fillet radius too much, since this can weaken the crankshaft at its most critical point.
2. Install new bearings with enlarged chamfers that allow proper fillet clearance.

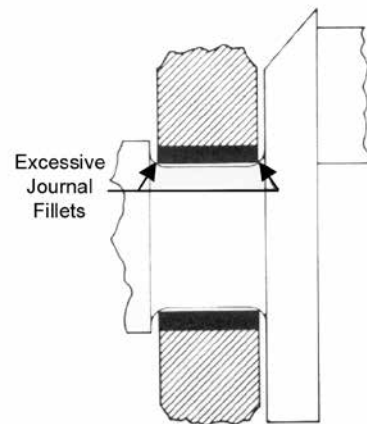
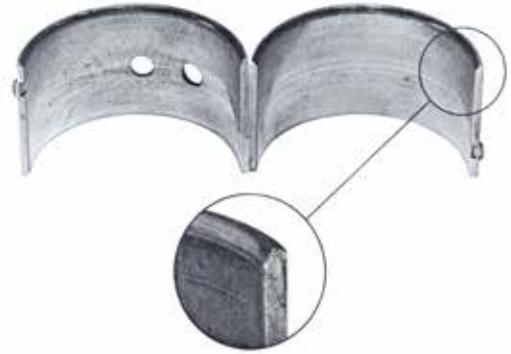

13 Distorted crankcase

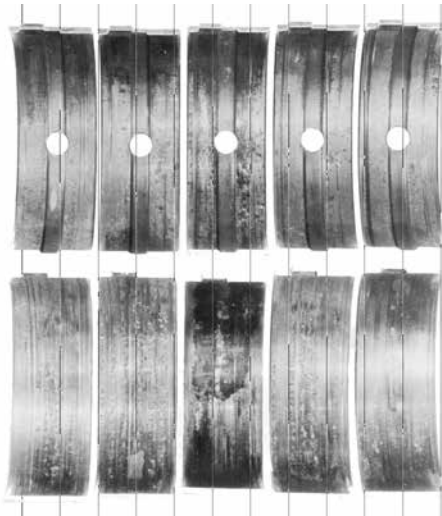

APPEARANCE

A wear pattern is visible on the upper or lower halves of the complete set of main bearings. The degree of wear varies from bearing to bearing depending upon the nature of the distortion. The center bearing usually shows the greatest wear.

DAMAGING ACTION

A distorted crankcase imposes excessive loads on the bearings, with the point of greatest load being at the point of greatest distortion. These excessive bearing loads cause excessive bearing wear. Also, oil clearance is reduced and metal-to-metal contact is possible at the point of greatest distortion.

POSSIBLE CAUSES

Alternating periods of engine heating and cooling during operation is a prime cause of crankcase distortion. As the engine heats the crankcase expands, and as it cools, the crankcase contracts. This repetitive expanding and contracting causes the crankcase to distort over time in some situations.

Distortion may also be caused by:

1. Extreme operating conditions (for example “overheating” and “lugging”)
2. Improper torquing procedure for cylinder head bolts, particularly with overhead valve V-8 engines

CORRECTIVE ACTION

1. Determine if distortion exists by use of Prussian blue or visual methods.
2. Align bore the housing (if applicable).
3. Install new bearings.

14 Bent crankshaft

APPEARANCE

A wear pattern is visible on the upper and lower halves of the complete set of main bearings. The degree of wear varies from bearing to bearing depending upon the nature of the distortion. The center bearing usually shows the greatest wear.

DAMAGING ACTION

A distorted crankshaft subjects the main bearings to excessive loads, with the greatest load being at the point of greatest distortion. The result is excessive bearing wear. Also, the oil clearance spaces between journals and bearings are reduced, making it possible for metal-to-metal contact to occur at the point of greatest distortion.

POSSIBLE CAUSES

A crankshaft is usually distorted due to extreme operating conditions, such as “over-speeding” and “lugging”. It may also be caused by improper handling prior to installation.

CORRECTIVE ACTION

1. Determine if distortion exists by means of Prussian blue or visual methods.
2. Install a new or reconditioned crankshaft.
3. Install new bearings.

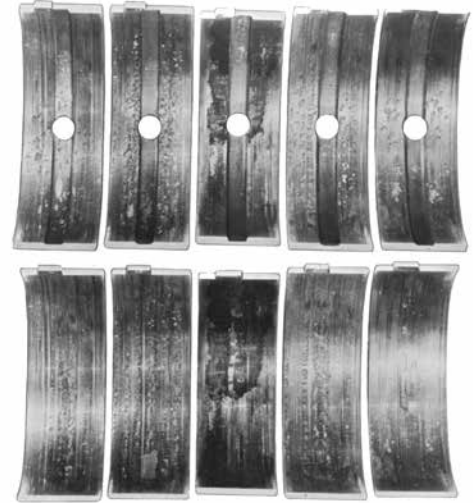

15 Out-of-round bore

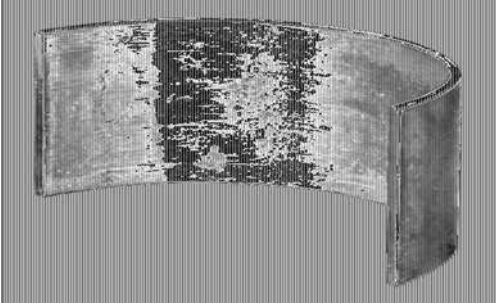

APPEARANCE

Localized excessive wear areas are visible near the parting line on both top and bottom shells.

DAMAGING ACTION

Oil clearance near the parting line is decreased to such an extent that metal-to-metal contact between bearing and journal takes place, resulting in areas of above-normal wear.

Also, improper seating between the bearing back and the housing bore may be present which hinders proper heat transfer causing localized heating of the bearing surface and thus reducing fatigue endurance.

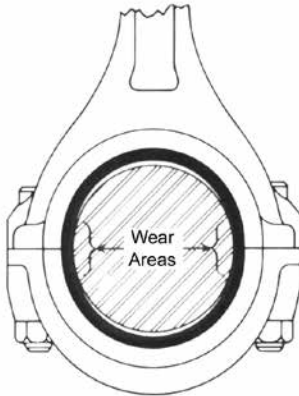

POSSIBLE CAUSES

Alternating loading and flexing of the connecting rod can cause the bearing housing to become elongated. And because replacement bearing shells, when installed, tend to conform to the shape of the bearing housing, this can result in an out-of-round bearing surface.

CORRECTIVE ACTION

1. Check the roundness of bearing housings before installing the new bearings. If they are found to be out-of-round, recondition the bearing housings (or replace connecting rod).
2. Check the journal surfaces for excessive wear and regrind if necessary.
3. Install new bearings.

16 Out-of-shape journal

APPEARANCE

In general, if a bearing has failed because of an out-of-shape journal, an uneven wear pattern is visible on the bearing surface. Specifically, however, these wear areas can be in any one of three patterns: Photo A above shows the wear pattern caused by a **tapered** journal. Photo B shows the wear pattern caused by an **hour-glass** shaped journal. Photo C shows the pattern of a **barrel** shaped journal.

DAMAGING ACTION

An out-of-shape journal imposes an uneven distribution of the load on the bearing surface, increasing heat generated and thus accelerating bearing wear. An out-of-shape journal also affects the bearing's oil clearance, making it insufficient in some areas and excessive in others, thereby upsetting the proper functioning of the lubrication system.

POSSIBLE CAUSES

If the journal is tapered there are two possible causes:

1. Uneven wear of the journal during operation (misaligned rod).
2. Improper machining of the journal at some previous time.

If the journal is **hour-glass** or **barrel** shaped, this is usually the result of improper machining or polishing.

CORRECTIVE ACTION

Regrinding the crankshaft can best remedy out-of-shape journal problems. Then install new bearings in accordance with proper installation procedures.

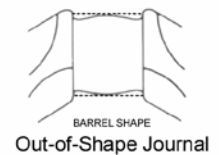
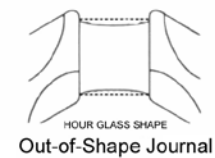
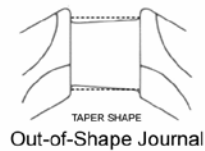
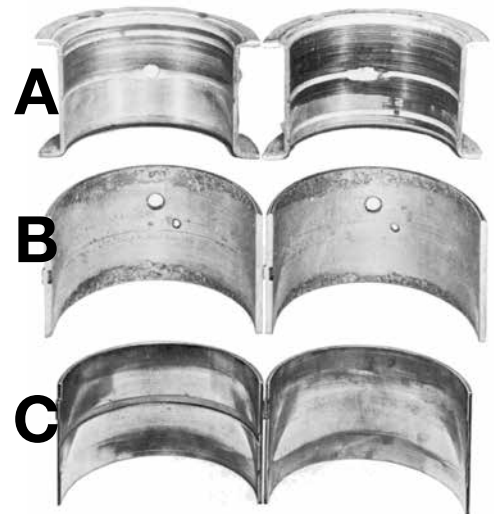

17 Oil starvation

APPEARANCE

When a bearing has failed due to oil starvation, its surface is usually very shiny. In addition, there may be excessive wear of the bearing surface due to the wiping action of the journal. In the most severe cases the bearing surface will be smeared or scratched and torn. The bearing will begin to turn dark blue to black in color.

DAMAGING ACTION

The absence of a sufficient oil film between the bearing and the journal permits metal-to-metal contact. The resulting wiping action causes premature bearing fatigue.

POSSIBLE CAUSES

1. Insufficient oil clearance – usually the result of utilizing a replacement bearing that has too great a wall thickness. In some cases, the journal may be oversized.
2. Broken or plugged oil passages, prohibiting proper oil flow.
3. A blocked oil suction screen or oil filter.
4. A malfunctioning oil pump or pressure relief valve.
5. Misassembling main bearings metering off an oil hole.
6. Lubrication system not primed before start up.

CORRECTIVE ACTION

1. Double-check all measurements taken during the bearing selection procedure to catch any errors in calculation. (During assembly check oil clearance with Plastigage®.)
2. Check to be sure that the replacement bearing you are about to install is the correct one for the application.
3. Check the journals for damage and regrind if necessary.
4. Check engine for possible blockage of oil passages, oil suction screen and oil filter.
5. Check the operation of the oil pump and pressure relief valve.
6. Be sure that the oil holes are properly indexed when installing the replacement bearings.
7. Advise the operator about the results of engine lugging.
8. Always prime the lubrication system before the engine is started the first time.

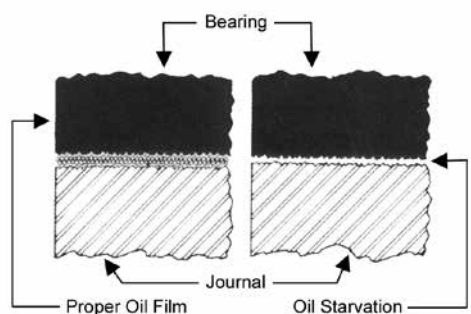
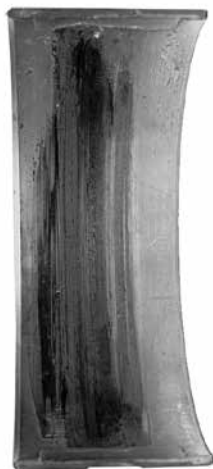

18 Hot short

APPEARANCE

Bearing surface wiped and torn, blackened from heat, with patches of lining material torn cleanly from steel backing.

POSSIBLE CAUSES

1. Breakdown of lubrication and resulting high friction elevates operating temperature.
2. Lead in bearing material melts and allows shaft to tear away patches of bearing lining.
3. Lack of lubrication.
4. Wiping.
5. Dirt contamination.
6. Concentrated loading (misalignment, etc.).

CORRECTIVE ACTION

A hot short is a catastrophic failure that results from one of the conditions already covered in detail. To properly correct this it must first be determined which specific condition lead to the hot short. For further details please see:

1. Foreign Particles in Lining (Page 8)
2. Foreign Particles on Bearing Back (Page 9)
3. Out-of-Round Bore (Page 18)
4. Excessive Crush (Page 12)
5. Bent or Twisted Connecting Rod (Page 14)
6. Shifted Bearing Cap (Page 11)
7. Distorted Crankcase (Page 16)
8. Bent Crankshaft (Page 17)
9. Oil Starvation (Page 20)
10. Misassembly (Page 10)



19 Surface fatigue

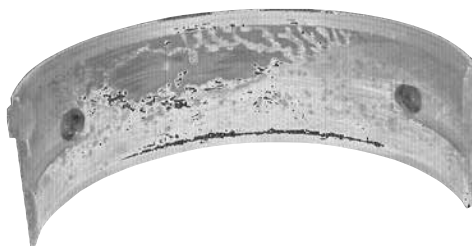

APPEARANCE

Bearing surface cracked, small irregular areas of surface material missing from the bearing lining.

DAMAGING ACTION

Heavy pulsating loads imposed upon the bearing by reciprocating motion within the engine cause the bearing surface to crack due to metal fatigue.

Fatigue cracks widen and deepen perpendicular to the bond line. Close to the bond line, fatigue cracks turn and run parallel to the bond line, eventually joining and causing pieces of the surface to flake out.

POSSIBLE CAUSES

1. Overloading (lugging, detonation, or overfueling).
2. Uneven loading (see sections on misalignment).
3. Bearing material of inadequate fatigue strength for application.
4. Bearing failure due to surface fatigue can be the result of the normal life span of the bearing being exceeded.

CORRECTIVE ACTION

1. If the service life for the old bearing was adequate, replace with the same type of bearing to obtain a similar service life.
2. If the service life of the old bearing was too short, replace with a heavier duty bearing to obtain a longer life.
3. Replace all other bearings (main connecting rod and camshaft) as their remaining service life may be short.
5. Check for misassembly. Use proper installation techniques.

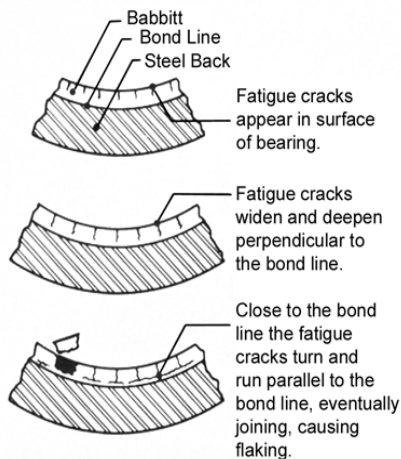

APPEARANCE

Bearing surface darkened, spongy, etched by chemical attack.

DAMAGING ACTION

This is usually the result of contamination of the oil from either the fuel system or internal engine leaks. This condition is further pronounced when there is poor routine maintenance.

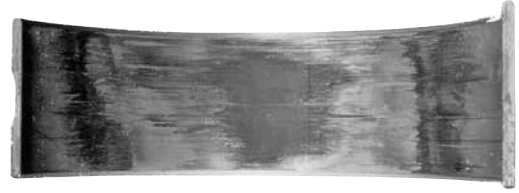

POSSIBLE CAUSES

1. Acids in oil.
2. Excessive operating temperature.
3. Excessive blow-by.
4. Coolant contamination of oil.
5. Use of high sulfur fuel.
6. Excessive oil change interval.

CORRECTIVE ACTION

1. Identify and correct source of contamination.
2. Install new bearings using correct installation procedures.
3. Use a better quality fuel, if possible.
4. Oil should be changed at recommended intervals using the proper grade and rating. In some applications oil analysis may be needed to determine the optimum oil change intervals.

21 Accelerated wear



APPEARANCE

Wall thickness reduced from original dimension. Bearing surface worn and polished but not smeared, torn or scored. No evidence of heat, no embedded foreign particles.

DAMAGING ACTION

Grinding and polishing the crankshaft journals produce burrs that are so small that we can't see or feel them. Not only is it important that the surface finish meet recommended average Ra or better, but it is also important to always grind opposite to rotation and polish in the direction of rotation. Otherwise it is possible for these microscopic burrs to disrupt the oil film and abrade away the bearing surface.

POSSIBLE CAUSES

1. Poor journal surface finish.
2. Wear in the presence of adequate lubrication to prevent heat build-up and wiping is caused by peaks in the journal surface finish profile which penetrate the oil film and abrade the bearing.

CORRECTIVE ACTION

1. Check journal surface finish for proper average Ra and regrind as needed.
2. If surface finish is acceptable lightly re-polish in the direction of rotation.
3. Install new bearings.

22 Crankshaft grinding and polishing

Crankshaft journal surfaces should be ground and polished to a surface finish of 15 micro inches roughness average Ra or better. Journals on highly loaded crankshafts such as diesel engines or high performance racing engines require a finish of 10 micro inches Ra or better.

The above is a simple straight forward specification which can be measured with special equipment. However, there is more to generating a ground and polished surface than just meeting the roughness specification. To prevent rapid, premature wear of the crankshaft bearings and to aid in the formation of an oil film, journal surfaces must be ground opposite to engine rotation and polished in the direction of rotation. This recommendation can cause a great deal of confusion in actual execution. Understanding the reasons behind the recommendation and examination of the following illustrations will help make the recommendation more clear.

Metal removal tends to raise burrs. This is true of nearly all metal removal processes. Different processes create different types of burrs. Grinding and polishing produces burrs that are so small that we can't see or feel them but they are there and can damage bearings if the shaft surface is not generated in the proper way. Rather than "burrs," let's call what results from grinding and polishing "microscopic fuzz." This better describes what is left by these processes. This microscopic fuzz has a grain or lay to it like the hair on a dog's back. Figure 1 is an illustration depicting the lay of this fuzz on a journal. (Note: All figures are viewed from nose end of crankshaft.) The direction in which a grinding wheel or polishing belt passes over the journal surface will determine the lay of the micro fuzz.

In order to remove this fuzz from the surface, each successive operation should pass over the journal in the opposite direction so that the fuzz will be bent over backward and removed. Polishing in the same direction as grinding would not effectively remove this fuzz because it would merely lay down and then spring up again. Polishing must, therefore, be done opposite to grinding in order to improve the surface.

In order to arrive at how a shaft should be ground and polished, we must first determine the desired end result and then work backwards to establish how to achieve it. Figure 2 depicts a shaft turning in a bearing viewed from the front of a normal clockwise rotating engine. The desired condition is a journal with any fuzz left by the polishing operation oriented so it will lay down as the shaft passes over the bearing (Figure 2).

The analogy to the shaft passing over the bearing is like petting a dog from head to tail. A shaft polished in the opposite direction produces abrasion to the bearing which would be like petting a dog from tail to head. To generate a surface lay like that shown in Figure 2, the polishing belt must pass over the shaft surface as shown in Figure 3.

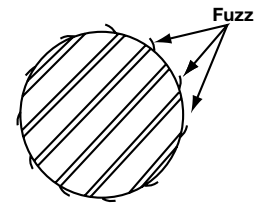

Fig. 1
Journal illustrating fuzz from grinding and polishing

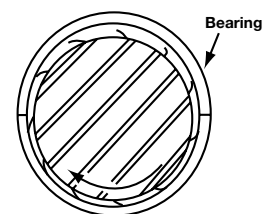

Fig. 2
Journal rotating in bearing with the grain of the fuzz

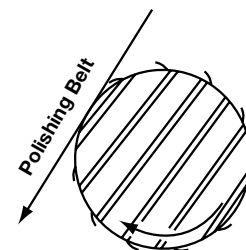

Fig. 3
Direction polishing belt should pass over journal and grain of fuzz which results

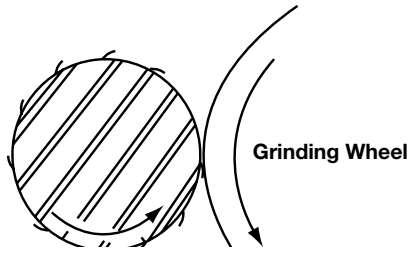

Fig. 4
 Directions of shaft and grinding wheel rotation and lay of
 fuzz which results

The direction of shaft rotation during polishing is not critical if a motorized belt type polisher is used because the belt runs much faster than the shaft. Stock removal during polishing must not exceed .0002" on the diameter.

Having determined the desired surface lay from polishing, we must next establish the proper direction for grinding to produce a surface lay opposite to that resulting from polishing. Figure 4 shows the grinding wheel and shaft directions of rotation and surface lay for grinding when viewed from the front or nose end of the crankshaft. This orientation will be achieved by chucking the flywheel flange at the left side of the grinder (in the headstock). Achieving the best possible surface finish during grinding will reduce the stock removal necessary during polishing.

The surface lay generated by grinding would cause abrasion to the bearing surfaces if left unpolished. By polishing in the direction shown in figure 3, the surface lay is reversed by the polishing operation removing fuzz created by grinding and leaving a surface lay which will not abrade the bearing surface.

Nodular cast iron shafts are particularly difficult to grind and polish because of the structure of the iron. Nodular iron gets its name from the nodular form of the graphite in this material. Grinding opens graphite nodules located at the surface of the journal leaving ragged edges which will damage a bearing. Polishing in the proper direction will remove the ragged edges from these open nodules.

All of the above is based on normal clockwise engine rotation when viewed from the front of the engine. For crankshafts which rotate counterclockwise, such as some marine engines, the crankshaft should be chucked at its opposite end during grinding and polishing. This is the same as viewing the crank from the flanged end rather than the nose end in the accompanying figures.

23 Premature thrust bearing failure

BACKGROUND

Although thrust bearings run on a thin film of oil, just like radial journal (connecting rod and main) bearings, they cannot support nearly as much load. While radial bearings can carry loads measured in thousands of pounds per square inch of projected bearing area, thrust bearings can only support loads of a few hundred psi. Radial journal bearings develop their higher load capacity from the way the curved surfaces of the bearing and journal meet to form a wedge. Shaft rotation pulls oil into this wedge shaped area of the clearance space to create an oil film, which actually supports the shaft. Thrust bearings typically consist of two flat mating surfaces with no natural wedge shape in the clearance space to promote the formation of an oil film to support the load.

Conventional thrust bearings are made by incorporating flanges at the ends of a radial journal bearing. This provides ease in assembly and this design has been used successfully for many years. Either tear-drop or through grooves on the flange faces and wedge shaped ramps at each parting line allow oil to enter between the shaft and bearing surfaces. However, the vast majority of the bearing surfaces and the entire shaft surface are flat making it much harder to create and maintain an oil film. If you have ever taken two gauge blocks and wiped them perfectly clean and pressed them together with a twisting action you know that they will stick together. This is very much like what happens as a thrust load applied to the end of a crankshaft squeezes the oil out from between the shaft and bearing surfaces. If the load is too great, the oil film collapses and the surfaces want to stick together, resulting in a wiping failure.

For many years some heavy-duty diesel engines have used separate thrust washers with a profiled face to enable them to support higher thrust loads. These thrust washers either have multiple tapered ramps and relatively small flat pads or have curved surfaces that follow a sine wave contour around their circumference.

CAUSES OF FAILURE

Aside from the obvious causes, such as dirt contamination and misassembly, there are only three common factors that generally cause thrust bearing failures. These are:

- Poor crankshaft surface finish
- Misalignment
- External overloading

SURFACE FINISH

Crankshaft thrust faces are difficult to grind because they are done using the side of the grinding wheel. Grinding marks left on the crankshaft face produce a visual swirl or sunburst pattern with scratches sometimes crisscrossing one another in a crosshatch pattern similar to hone marks on a cylinder wall. If these grinding marks are not completely removed by polishing, they will remove the oil film from the surface of the thrust bearing much like multiple windshield wiper blades.

A properly finished crankshaft thrust face should only have very fine polishing marks that go around the thrust surface in a circumferential pattern. A surface finish of 15 Ra or less is recommended (10 Ra or less for heavy duty or highly loaded engines).

ALIGNMENT

The grinding wheel side face must be dressed periodically to provide a clean, sharp cutting surface. A grinding wheel that does not cut cleanly may create hot spots on the work piece leading to a wavy, out-of-flat surface. The side of the wheel must also be dressed at exactly 90° to its OD to produce a thrust face that is square to the axis of the main bearing journal.

When assembling thrust bearings:

1. Tighten main cap bolts to approximately 10 to 15 ft. lbs. to seat bearings then loosen.
2. Tap main cap toward rear of engine with a soft-faced hammer.
3. Tighten main cap bolts, finger tight.
4. Using a bar, force the crankshaft as far forward in the block as possible to align bearing rear thrust faces.
5. While holding shaft in forward position, tighten main cap bolts to 10 to 15 ft lbs.
6. Complete tightening main cap bolts to specifications in 2 or 3 equal steps.

The above procedure should align the bearing thrust faces with the crankshaft to maximize the amount of bearing area in contact for load carrying.

LOADING

A number of factors may contribute to wear and overloading of a thrust bearing, such as (in no specific order):

- Excessive pump pressure
- Torque converter expansion
- Torque converter internal wear
- Pump drive gear installed backwards
- Wrong torque converter
- Wrong flex plate
- Wrong flywheel bolts
- Misalignment of the engine and the major transmission components
- Improper throw out bearing adjustment
- Riding the clutch pedal

DIAGNOSING PROBLEMS

By the time a thrust bearing failure becomes evident, the parts have usually been so severely damaged that there is little if any evidence of the cause. The bearing is generally worn into the steel backing which has severely worn the crankshaft thrust face as well. So how do you tell what happened?

23 Premature thrust bearing failure cont'd.

Start by looking for the most obvious internal sources:

- Is there evidence of distress anywhere else in the engine that would indicate a lubrication problem or foreign particle contamination?
- Were the proper bearing shells installed correctly?
- If the thrust bearing is in an end position, was the adjacent oil seal correctly installed? An incorrectly installed rope seal can cause sufficient heat to disrupt bearing lubrication.
- Examine the un-failed thrust face on the crankshaft for surface finish and geometry. This may give an indication of the original quality of the failed face.
- Once you are satisfied that all potential internal sources have been eliminated; ask about potential external sources of either overloading or misalignment.
- Did the vehicle have a prior thrust bearing failure?
- What external parts were replaced?
- Was the correct transmission installed?
- Was the correct torque converter installed?
- Was the correct flex plate used? At installation there should be a minimum of 1/16" (1/8" preferred) clearance between the flex plate and converter to allow for converter expansion.
- Were the correct flex plate mounting bolts used?
- Is there evidence of the converter hitting the flex plate mounting bolts?
- Was the transmission properly aligned to the engine?
- Were all dowel pins in place?
- Check condition of pilot bearing.
- If a used torque converter was re-used, is it worn internally?
- If a rebuilt transmission was installed, did the torque converter engage the pump drive spline properly? An improperly installed pump drive gear may prevent full engagement of the converter.
- Was the transmission pump pressure checked and found to be within specification?
- Check external transmission cooling lines and heat exchanger for restrictions that will increase pump pressure.
- If a manual transmission was installed, was the throw out bearing properly adjusted?
- What condition was the throw out bearing found to be in? A properly adjusted throw out bearing that is worn or overheated may indicate the operator was "Riding the Clutch".

HELP FOR THE THRUST BEARING

When a problem application is encountered, every effort should be made to find the cause of distress and correct it before completing repairs or you risk a repeat failure.

A simple modification to the upper thrust bearing may help in problem applications. Install the upper thrust bearing in the block to determine which thrust face is toward the rear of the engine.

Using a small, fine tooth, flat file, increase the chamfer on the ID edge of the bearing parting line from the oil groove to the rear thrust face only. (See diagram.) This enlarged ID chamfer will allow pressurized oil from the bearing oil groove to reach the loaded thrust face without passing through the bearings clearance space first. Since there is a load against the rear thrust face, the load should restrict oil flow and there should not be a noticeable loss in oil pressure. Although this modification is not a guaranteed cure-all it should help if all other conditions, such as surface finish, alignment, cleanliness and loading are within reasonable limits.

RECENT DEVELOPMENTS

In the past few years some new automotive engine designs have begun using various methods to enable them to carry higher thrust loads imposed by some of the newer automatic transmissions. The use of thrust washers exclusively, a combination of thrust washers and flange bearings, radial grooving (a series of 3 - 5 straight grooves on the flange face), flange bearings with profiled (ramp and pad design) flange faces, or assembled flanges (separate thrust washers which are mechanically attached to the bearing). It is important to keep in mind that most of these developments are application specific and may not be available or even feasible for older applications.

24 Preventing premature cam bearing failure

For many years, nearly all camshaft bearings were manufactured with a lining of babbitt. Babbitt is a soft slippery material made up primarily of lead and tin and is quite similar to solder. As a bearing surface layer, babbitt possesses the desirable properties necessary to survive under adverse conditions such as foreign particle contamination, misalignment and marginal lubrication on start up.

The trend in modern engines has been toward higher operating temperatures and higher valvetrain loads. Babbitt is limited in its ability to survive under these conditions due to its relatively low strength. When babbitt cam bearings are installed under these demanding conditions, the lining may extrude or fatigue. Fatigue can be identified by craters in the bearing surface where sections of lining material have flaked out.

To meet the demands of higher loads and operating temperatures in modern engines as well as the requirements imposed by high performance, babbitt has been replaced by an alloy of aluminum. This aluminum alloy is much stronger than babbitt and will withstand several times the load. However, this added strength is obtained at the expense of some of the more forgiving properties of babbitt. The aluminum alloy is harder, making it somewhat less compatible with dirt, misalignment and marginal lubrication. This is typical of the compromises or trade offs that are frequently necessary when selecting a bearing material to suit the requirements of a specific application and in this case, higher loading.

Typically, whenever a higher level of loading is encountered, greater precision is required to maintain reliability. Conditions such as cleanliness, alignment, clearances, journal surface finishes and lubrication must all be controlled more closely. The following are some recommendations to help optimize performance when using aluminum alloy camshaft bearings.

Sufficient clearance is necessary in the initial installation. These stronger bearings will not wear in rapidly to make their own clearance like softer babbitt materials. Minimum clearance should be .002" for stock engines and .003" for high performance. Optimum clearance range for high performance applications is .003" to .004". Because of the stack up of tolerances on the block, shaft and bearing it is impossible to control clearance to this range in the manufacture of the bearing alone. Clearances must be measured at installation.

Honing the IDs of cam bearings to increase clearance is not recommended because hone grit may become embedded in bearing surfaces that will cause shaft wear. Bearing IDs may be reamed, but the most practical means is to adjust camshaft journal diameters by grinding the journal. Even if not ground to provide additional clearance, camshaft bearing journals should be polished to the proper surface finish with the camshaft rotating in the same direction it will rotate in the engine.

Like clearance, alignment is also extremely important especially for high performance applications. Any block that has needed to have its main bearing bore alignment corrected due to distortion is likely to have experienced cam bearing bore distortion as well. Adequate clearance can help compensate for minor misalignment of less than .001".

Installation of bearings into the block must be done with care to avoid shaving metal off the backs of the bearings. This galling action may cause a build-up of metal between the bearing OD and the housing bore which will result in a reduction in clearance. To prevent galling, check housing bores for a proper 25 to 30 degree lead-in chamfer before installing cam bearings. On blocks without grooves behind the cam bearings, care must be taken to insure that oil holes line up between the bearings and block. Where the block has a groove behind the bearing, the bearing should be installed with the oil hole at the 2 o'clock position when viewed from the front for normal clockwise camshaft rotation. This will introduce oil into the clearance space outside of the loaded area and allow shaft rotation to build an oil film ahead of the load.

25 Crankshaft thrust faces

Crankshaft surface finish and shape are key factors affecting the performance of all bearings. These factors become even more critical for thrust surfaces. As in any bearing, increased loading reduces oil film thickness between shaft and bearing surfaces. This is a much more critical situation in thrust bearings due to their flat faces which make formation of an oil film extremely difficult. Radial bearings (those which carry loads in a radial direction like rod and main bearings) form a natural wedge where shaft and bearing surfaces come together in the clearance space. Shaft rotation pulls a wedge of oil into the loaded area of the bearing and forms an oil film that supports the load.

Thrust faces, on the other hand, are made up of two flat surfaces that do not form a natural wedge where they meet. In order to help form an oil film, artificial wedge shaped areas are machined into the bearing surfaces at the ends and sometimes adjacent to the grooves. In spite of all the common design efforts, thrust bearings still run on a much thinner film of oil that makes crankshaft surface finish critical in the successful performance of these bearings.

Recent samples of thrust face surface finish on crankshafts from blown fuel "Hemi" engines have confirmed that better finishes resulted in a reduced rate of bearing distress. The study also showed that when no damage occurred, the crankshaft surface finish was improved after running. The surface finishes of 12 crankshafts were measured (7 new and 5 used). The new shafts ranged from a high of 30 Ra to a low of 5 Ra. The used shafts had a very similar range from 31Ra to 4 Ra. Although this represents only a small sampling, it does demonstrate a correlation between surface finish and performance when the condition of mating bearing surfaces was evaluated. Prior to these measurements, race experience had shown no problems on a crankshaft with a thrust-face Ra of 6 and did show problems on crankshafts when the Ra was over 20.

Obtaining a good finish on the thrust face of a crankshaft is difficult to do because it uses side-wheel grinding. Side grinding causes marks that spiral outward toward the OD of the thrust face and may also cause crosshatch marks resembling honing patterns. Both patterns are detrimental to the formation of an oil film because they work like wipers as the shaft rotates. Grinding marks must be removed by polishing. Only a circular pattern should remain. Surface finish should be checked in a tangential direction and must be held to 10 Ra max. The thrust surface should be flat within .0002" max.

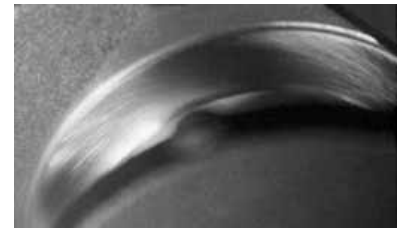

avoid - swirl pattern

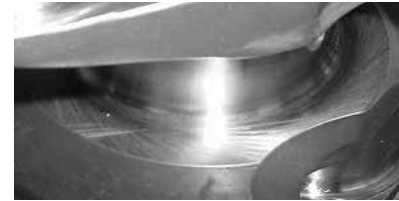

avoid - crosshatch pattern

MAHLE

Driven by performance



MAHLE Aftermarket Inc.
23030 MAHLE Drive
Farmington Hills, MI 48335
United States
Phone +1 (800) 338-8786
Fax +1 (248) 596-8899



www.mahle-aftermarket.com

OEB-2-1114

